



20100609 01230726

客服热线(Tel): +86-577-62759735

www.lanig.cn

MADE IN CHINA

LGM12-KLA□-□□

2m-PVC/PUR[Shielding]

传感器/执行器电缆

M12 孔式 弯头 A编码 +自由出线端



产品一级目录

传感器/执行器电缆

产品二级目录

LGM12-A标准系列

K

L

A

商务数据

产品名称	M12传感器/执行器电缆(简称"M12连接器")
型号规格	LGM12-KLA□-□□
包装	1 Pcs.
包装尺寸	220*160mm
外包装尺寸	320*320*200mm

产品遵循标准

- [1]引脚分配和测试符合IEC 61076-2-101标准
- [2]编码符合IEC60947-2标准;
- [3]防护等级IP67 符合EN60529;
- [4]防振和抗冲击能力符合IEC60512-4标准。



ROHS认证 CE认证 ISO9001认证 IP68防尘、防水测试合格

技术数据

一般数据

芯数	3	4	5	8	12	17
额定电流(40°C)	4 A			2 A	1.5 A	
额定电压	250 V		60 V	30 V	30 V	
导线横截面	0.34mm ² [AWG22]		0.25mm ² [AWG24]		0.14mm ² [AWG26]	
接触电阻	≤ 5 mΩ					
绝缘电阻	≥ 100 MΩ					
电缆长度	2.0 m					
电缆自由出线端剥线长度	35mm					
每件净重	0.090kg	0.093kg	0.095kg	0.115kg	0.126kg	0.145kg
环境温度(运行)	-25 °C ... 90 °C					

技术特性

技术标准/规范	IEC61076-2-101 ; IEC60947-2
防插错编码	A-标准
电涌电压类别	II
污染等级	3
保护等级	IP65/IP68/IP69K防护等级
插/拔周期	≥100
扭 矩	0.4Nm
接触件材料	CuSn
材料接触表面	Ni/Au
芯端材料	PA66
包胶材料	TPE
锁紧螺母	铜H59 镀镍
O型圈材质	NBR

线缆技术参数

芯 数	3	4	5	8	12	17
线缆护套材质	PVC <input type="checkbox"/>	PUR <input type="checkbox"/>	PVC[Shielding] <input type="checkbox"/>	PUR[Shielding] <input type="checkbox"/>		
芯线横截面积	0.34mm ² [AWG22]		0.25mm ² [AWG24]		0.14mm ² [AWG26]	
AWG 信号线	22		24		26	
护套颜色	黑色					
芯线颜色	详见《布线示意图》					
绝缘电阻	≥100MΩ*km(20°C)					
导线电阻	< 58Ω/km(20°C)			< 78Ω/km(20°C)	< 142Ω/km(20°C)	
芯线结构	42/0.10±0.008mm		32/0.10±0.008mm		18/0.10±0.008mm	
线缆外径 OD	5.0±0.10			5.5±0.10	6.0±0.10	7.0±0.10
最小弯曲半径, 固定式安装	22mm	23.5mm	25mm	48mm	70mm	85mm
最小弯曲半径, 移动式安装	44mm	47mm	50mm	60mm	85mm	100mm
弯折次数	4000000				2000000	
横向轨迹	10m					
横向速度	3m/s					
加速度	10m/s ²					
阻 燃	符合DIN UL20549					
无卤素	符合DIN VDE 0472第815章					
环境温度	-40 °C ... 80 °C(固定式安装)					
	-25 °C ... 80 °C(活动式安装)			-5 °C ... 80 °C(活动式安装)		

认证/许可

认证

CE 3N210104.YLE0008

RoHS B-R201234133



外形尺寸图

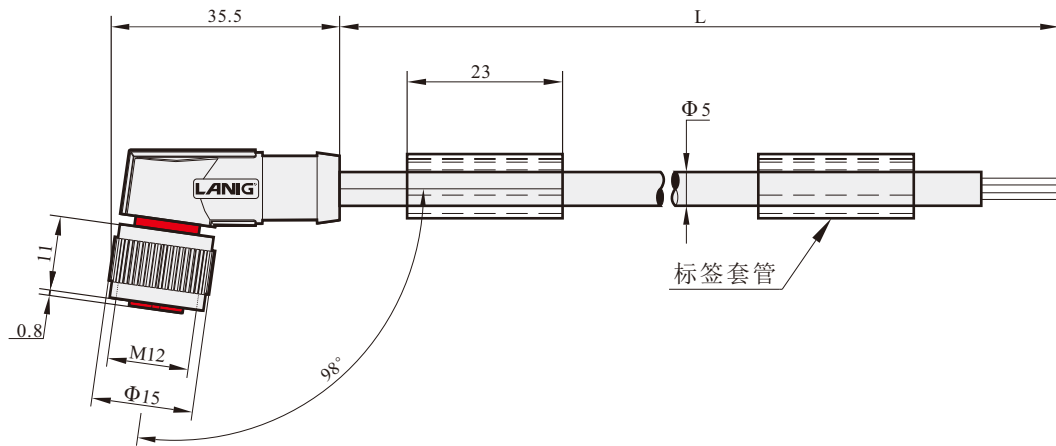

针位及布线示意图

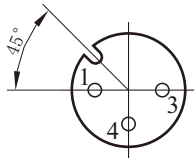

孔位	颜色
1	棕色/brown
2	-
3	蓝色/blue
4	黑色/black

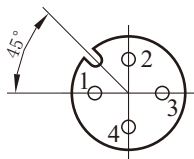
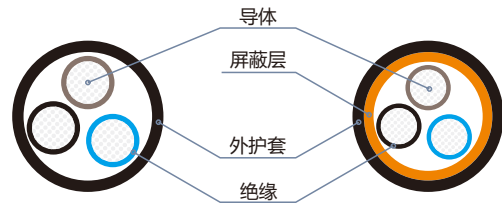

孔位	颜色
1	棕色/brown
2	白色/white
3	蓝色/blue
4	黑色/black

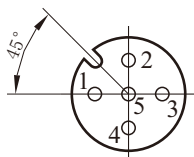
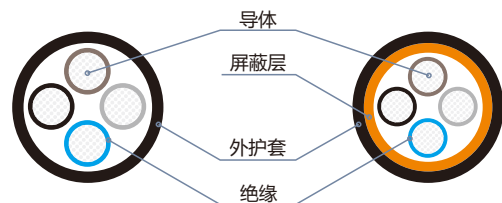

孔位	颜色
1	棕色/brown
2	白色/white
3	蓝色/blue
4	黑色/black
5	灰色/grey

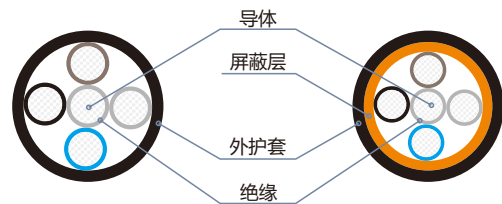



产品一级目录
传感器/执行器电缆

产品二级目录
LGM12-A标准系列

K L A

针位及布线示意图

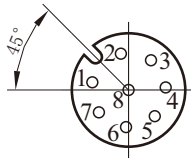

孔位	颜色
1	白色/white
2	棕色/brown
3	绿色/green
4	黄色/yellow
5	灰色/grey
6	粉色/pink
7	蓝色/blue
8	红色/red或屏蔽/shield

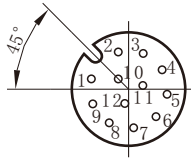
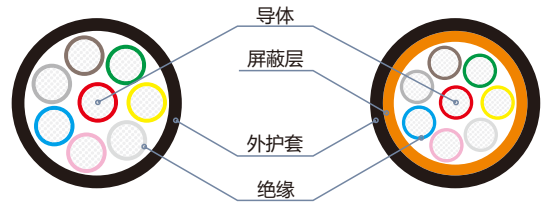

孔位	颜色
1	棕色/brown
2	蓝色/blue
3	白色/white
4	绿色/green
5	粉色/pink
6	黄色/yellow
7	黑色/black
8	灰色/grey
9	红色/red
10	紫色/VT
11	灰&粉色/GYPK
12	红&蓝色/RDBU

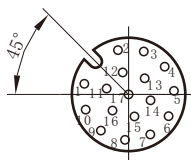
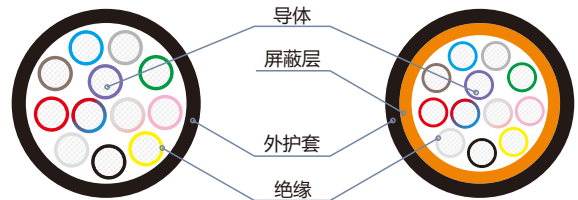

孔位	颜色
1	棕色/brown
2	蓝色/blue
3	白色/white
4	绿色/green
5	粉色/pink
6	黄色/yellow
7	黑色/black
8	灰色/grey
9	红色/red
10	紫色/VT
11	灰&粉色/GYPK
12	红&蓝色/RDBU
13	白&绿色/WHGN
14	棕&绿色/BNGN
15	白&黄色/WHYE
16	黄&棕色/YEBN
17	白&灰色/WHGY

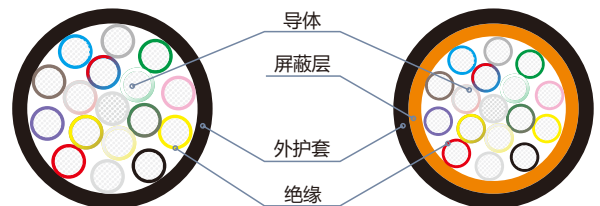



产品一级目录

产品二级目录

K L A

传感器/执行器电缆

LGM12-A标准系列

额定衰减曲线图

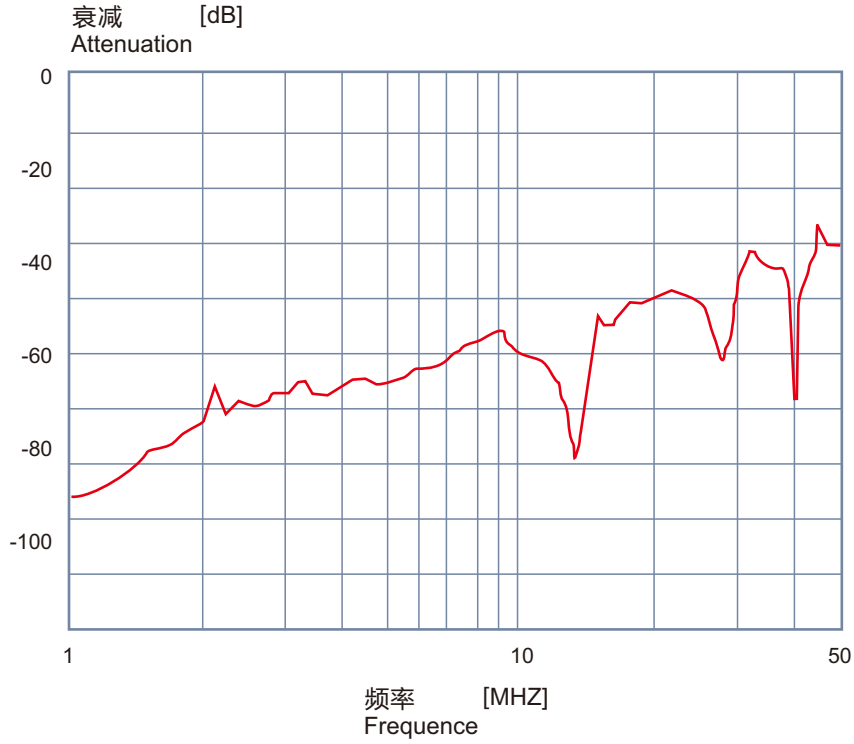

降低额定值特征

